

CATALOG NUMBER	TYPE
PROJECT	

FLEXRAIL2 – LINE VOLTAGE TRACK HEAD

SERIES HM-757

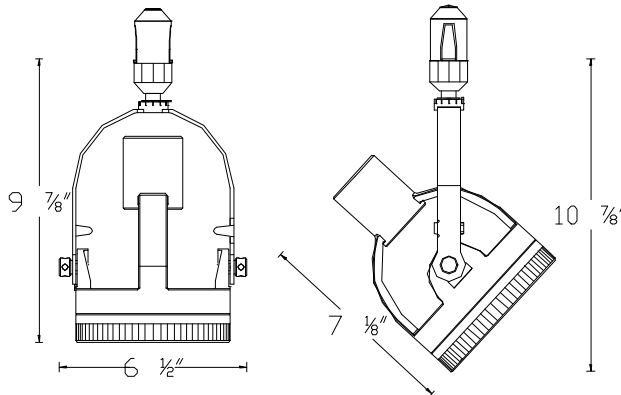



Ordering Matrix			
Series	Model	Finish	Accessories
<input type="text"/>	<input type="text"/>	<input type="text"/>	<input type="text"/>
HM	757	BZ PT	See table below

Ordering Example (series number – model number – finish + accessory): HM-757-PT + Lens-38-CRL

Product Details	
Description:	Flexrail2 compatible precision module style line voltage track head utilizing PAR38 lamps. Lens cap comes with an internal tension springs that allows for the use of two captive lens accessories.
Materials:	All die-cast aluminum fixture with heavy gauge aiming screws painted to match fixture finish. Medium base porcelain socket with nickel-plated copper screw shell.
Aiming:	350° horizontal rotation and 90° vertical aiming with built-in degree scales on fixture. Two locking screws (one on each side of fixture) allow for locking fixture aiming angle.
Lamping:	Uses PAR38 lamp. 150W maximum.
Finish:	Abrasion resistant platinum or bronze paint finish. BZ = Designer Bronze metal finish PT = Platinum metal finish
Listing:	UL & CUL Listed. Patent Pending.
Accessories:	Accepts one or two accessories within the lens cap. Compatible accessories are ordered separately.

Specification Features
<ul style="list-style-type: none"> Die-cast aluminum fixture with integral aiming indicators to assure precise directional adjustment. Quarter turn lens cap has inner tension springs that allow for the use of multiple captive lens accessories. PAR38 lamp beam spreads available in choices ranging from 8 to 60 degrees to allow for a wide variety of application specific lighting patterns. 5 year product warranty.

Compatible Accessories			
LENS-38-CRL Cross Louver 	LENS-38-HCL Honeycomb Louver 	LENS-38-COLOR Colored Lenses AMB = Amber BLU = Blue GRN = Green RED = Red YEL = Yellow 	LENS-38-DIC-COLOR Dichroic Lenses AMB = Amber BLU = Blue GRN = Green RED = Red YEL = Yellow 