

# FÜGÜ – model: G924

## Eternity Jewelry Collection Glass Pendant

# WAC LIGHTING

## Responsible Lighting®

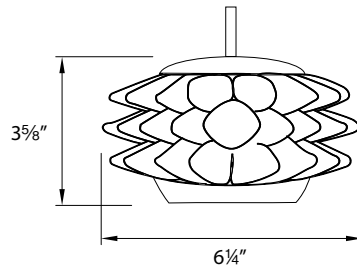

Fixture Type:

Catalog Number:

Project: \_\_\_\_\_

Location: \_\_\_\_\_

### PRODUCT DESCRIPTION

Fugu is the Japanese word for pufferfish and the dangerous delicacy prepared from it, lethally poisonous if not skillfully prepared and exceedingly extravagant to indulge. This mouth-blown Italian glass representation with embedded 24K gold flecks and hand-pulled spikes of sparkling clear glass credits the toxic beauty of these wonders of the sea.

### FEATURES

- LED or Low voltage xenon lamping
- Can be used on canopies, all Quick Connect™ systems and line voltage rail and track systems
- All socket sets include 72" wire that may be cut in the field
- 5 year WAC Lighting product warranty
- UL & CUL Listed

### CONSTRUCTION

- **LED or Low Voltage Socket Set:** Machined Aluminum
- **MP Canopy:** Steel
- **Adapters – Solorail™, Duorail™:** Copper
- **Adapters – 120V Track, Flexrail 1:** Polycarbonate

### COMPATIBLE SYSTEMS

#### Canopy (MP)

LED or Low Voltage xenon lamp

Includes:

- Shade
- Quick Adjust™ Canopy (shown)
- Socket Set
- Lamp



The patent pending Quick Adjust™ Canopy has an adjustable cable that stores inside the canopy housing for easy in-field height adjustments.

*Sold as a complete unit with a single Order Number, no adapters needed.*

#### Quick Connect™ (QP)

LED or Low Voltage xenon lamp

Includes:

- Shade
- Threaded Male Connector (shown)
- Socket Set
- Lamp



For use on 120V Track, Solorail™, Duorail™, and Flexrail 1™ with proper Quick Connect™ adapter (sold separately).

Can also be used on any Quick Connect™ Canopy (sold separately) no adapter needed.

*Threaded Male Connector easily joins with all Quick Connect™ Adapters and Canopies.*

**For Lamp Specifications and Ordering Information see next page.**

#### WAC Lighting

www.waclighting.com

Phone (800) 526.2588 • Fax (800) 526.2585

#### Headquarters/Eastern Distribution Center

44 Harbor Park Drive • Port Washington, NY 11050

Phone (516) 515.5000 • Fax (516) 515.5050

#### Western Distribution Center

1750 Archibald Avenue • Ontario, CA 91760

Phone (800) 526.2588 • Fax (800) 526.2585

# FÜGÜ – model: G924

## Eternity Jewelry Collection Glass Pendant

# WAC LIGHTING

Responsible Lighting®

### SOCKET SET and LAMP INFORMATION

#### Low Voltage

Lamp: 12V Xenon BP-50 (included)

Power: 50W max

- May be dimmed
- Includes collar with threaded set screw to allow for varying lamp positions inside the shade
- DO NOT rest glass on socket base

Includes 12V, 50W xenon bi-pin

Use LED Bulb in this Socket Set:

Power: 2W

Lumens: 110

Color Temperature: 3000K

CRI: 85

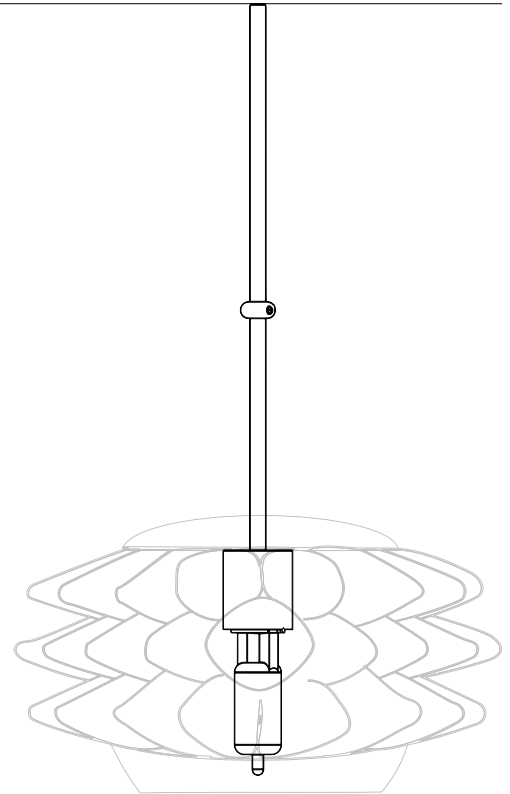

System	Model	Lamping	Shade Finish	Socket Finish
<b>MP</b> Canopy	<b>924LED</b>	LED	<b>GL</b> Gold	<b>BN</b> Brushed Nickel
<b>QP</b> Quick Connect™	<b>924</b>	Xenon		<b>CH</b> Chrome
				<b>DB</b> Dark Bronze

Example: **QP924LED-GL/BN**

Canopy models (MP) include Quick Adjust™ canopy  
Quick Connect™ (QP) models require additional adapter

System    Model #    Color    Finish

-  /

Example: **QP924LED-GL/BN**

### SOCKET FINISHES

**BN** - Brushed Nickel



**CH** - Chrome



**DB** - Dark Bronze



### WAC Lighting

www.waclighting.com

Phone (800) 526.2588 • Fax (800) 526.2585

### Headquarters/Eastern Distribution Center

44 Harbor Park Drive • Port Washington, NY 11050

Phone (516) 515.5000 • Fax (516) 515.5050

### Western Distribution Center

1750 Archibald Avenue • Ontario, CA 91760

Phone (800) 526.2588 • Fax (800) 526.2585





# FÜGÜ – model: G924

## Eternity Jewelry Collection Glass Pendant

# WAC LIGHTING

Responsible Lighting®

### QUICK CONNECT™ ADAPTERS (order one per fixture)

Solorail™	Model #	Finish	Duorail™	Model #	Finish
	<b>LM-QADP</b>	<b>BN</b> <b>CH</b> <b>DB</b>		<b>LM2-QADP</b>	<b>BN</b> <b>CH</b> <b>DB</b>
Flexrail1™	Model #	Finish	120V Track	Model #	Finish
	<b>HM1-EN50</b>	<b>DB</b> <b>PT</b>		<b>EN-LQ50AR</b> <b>EN-HQ50AR</b> <b>EN-JQ50AR</b>	<b>BK</b> <b>BN</b> <b>DB</b> <b>WT</b>

### ORDER NUMBER



Model #  – Finish

Example: **LM-QADP-BN**

### QUICK CONNECT™ CANOPIES with INTEGRAL DRIVER

			
Model # <b>QMP-60ERN</b>	Model # <b>QMP-G1RN</b>	Model # <b>QMP-G3RN</b>	Model # <b>QMP-G3RE</b>
Finish <b>BN</b> <b>CH</b> <b>DB</b>	Finish <b>MR</b>	Finish <b>MR</b>	Finish <b>MR</b>

### QUICK CONNECT™ CANOPIES for use with REMOTE TRANSFORMER

		
Model # <b>QMP-MI-TR</b>	Model # <b>QMP-1RN-TR</b>	Model # <b>QMP-1SQ-TR</b>
Finish <b>BN</b> <b>CH</b> <b>DB</b>	Finish <b>BN</b> <b>CH</b> <b>DB</b>	Finish <b>BN</b> <b>CH</b> <b>DB</b>

### ORDER NUMBER

Model #  – Finish

Example: **QMP-60ERN-BN**

### FINISHES

<b>BK</b> - Black	<b>BN</b> - Brushed Nickel	<b>CH</b> - Chrome	<b>DB</b> - Dark Bronze	<b>MR</b> - Mirror	<b>PT</b> - Platinum	<b>WT</b> - White
						

WAC Lighting  
www.waclighting.com  
Phone (800) 526.2588 • Fax (800) 526.2585

Headquarters/Eastern Distribution Center  
44 Harbor Park Drive • Port Washington, NY 11050  
Phone (516) 515.5000 • Fax (516) 515.5050

Western Distribution Center  
1750 Archibald Avenue • Ontario, CA 91760  
Phone (800) 526.2588 • Fax (800) 526.2585