

INSTRUCTIONS

Models:

Low Voltage Multiple Recessed Housings

MT-116HS, MT-216HS, MT-316HS, MT-416HS

CAUTION

- Always turn off power at the circuit breaker panel or fuse box prior to installation to prevent electrical shock.
- Do not install insulation within 3" of housing.

Designed for installation in dropped grid ceilings or to joist members in new construction ceilings.

Note: For trimless installation, please install the bracket with screws provided.

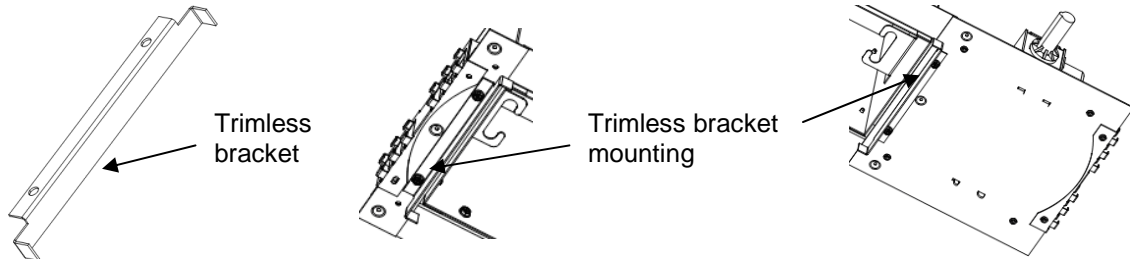

1. Supplied with two hanger bars, (24" max). Bars can be used on both sides and are notched on the ends to fit over "T" bars in suspended ceilings. Hanger bars include a captive mounting "screw-nail" for ease of installation. Align the bottom of the hanger bar with the bottom of the wood joist. Secure the "screw-nail" on each end by screwdriver (as fig A), or by hammer (as fig B).
2. Draw supply wire (½" trade size flexible metal conduit or non-metallic sheathed cable) from ceiling to fixture site.
3. To make electrical connections:
 - a. Route supply wire to junction box opening with suitable connector.
 - b. Connect black transformer wire to black supply wire with wire nut.
 - c. Connect white transformer wire to white supply wire with wire nut.
 - d. Connect Green grounding wires with wire nut. (Wire may be green or un-insulated)
 - e. Close junction box cover.
4. Install ceiling.
5. Use template supplied to make appropriate cutout for trim installation.

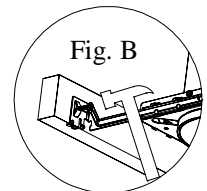
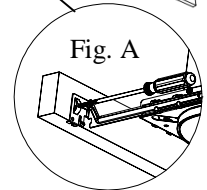
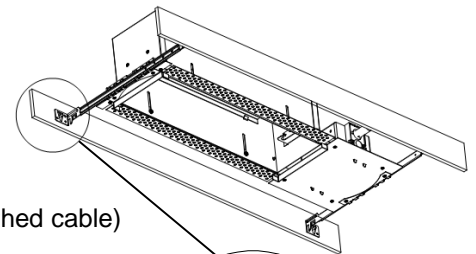

To Install Trim

- a. Raise the trim to the housing and attach by squeezing the torsion springs and guiding them through the anchor cleats.
- b. Pull sockets through the holes and attach to MR16 lamps.
- c. Secure lamps onto trim using retaining springs provided.

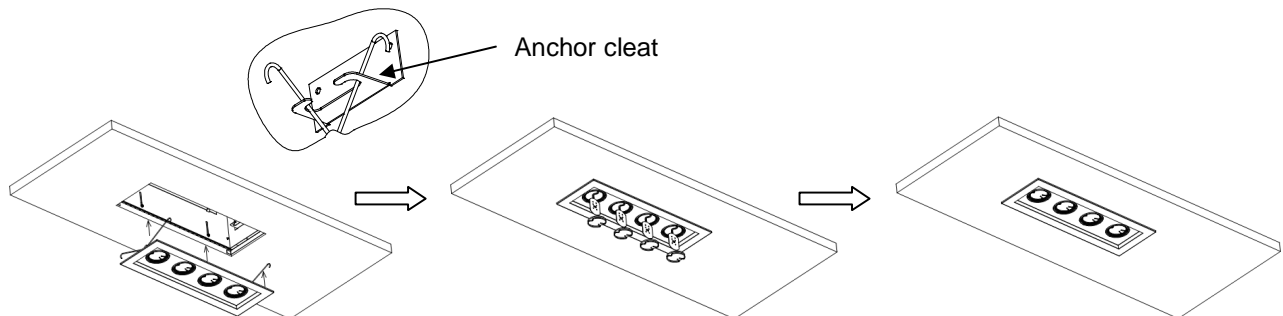

Trimless Installation

Note: For trimless installation, please install the bracket with screws provided.

- a. Raise screen panel to ceiling opening and secure with screws supplied.
- b. Apply plaster over screen panel and sand surface when dry for a finish look.

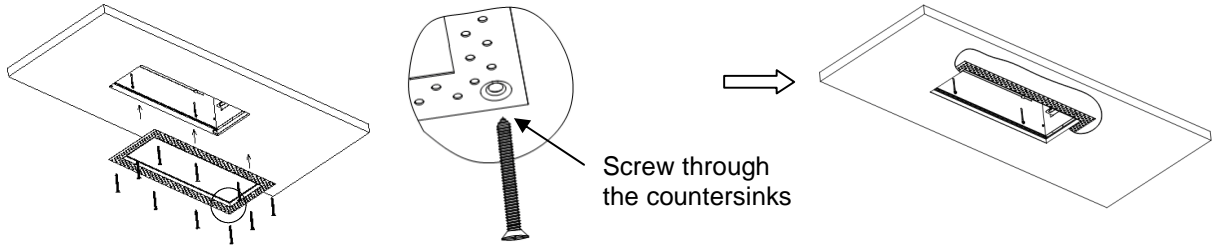

- c. Raise the trim to the housing and attach by squeezing the torsion springs and guiding them through the anchor cleats.
- d. Pull sockets through the holes and attach to MR16 lamps.
- e. Secure lamps onto trim using retaining springs provided.

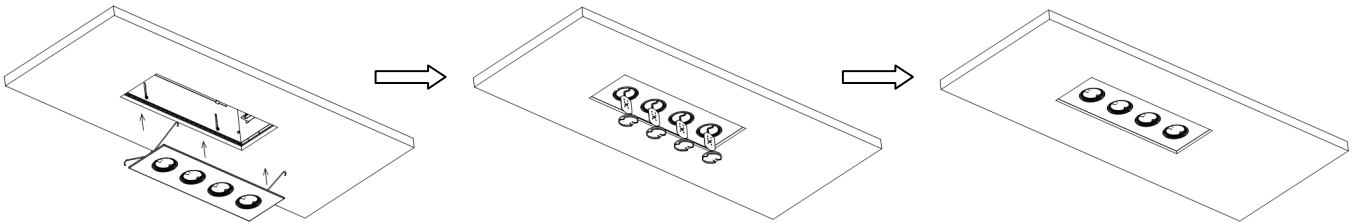

To Service Transformer

Gain access to the junction box, by removing the 4 screws securing housing shell, and pulling down or pushing aside enough to allow sufficient hand space.

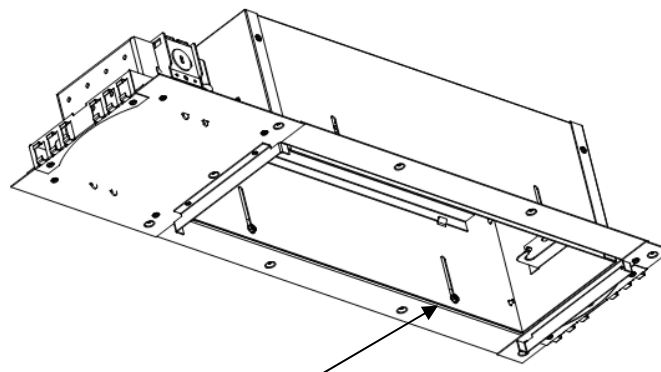

Housing shell screws
(2 each side)

Retain instructions for maintenance reference.