

## **WARNING**

**IMPORTANT: NEVER attempt any work without shutting off the electricity.**

- Read all instructions before installing.
- System is intended for installation by a qualified electrician in accordance with the National Electrical Code and local regulations.
- Go to the main fuse box, or circuit breaker. Place the main power switch in the "OFF" position and unscrew the fuse(s) or switch "OFF" the circuit breaker switch(es) that control the power to the fixture or room that you are working on.
- Place the wall switch in the "OFF" position.

### **CAUTION**

- All parts must be used as indicated in these instructions. Do not substitute any parts, leave parts out, or use any parts that are worn out or broken. Failure to follow this instruction could invalidate the ETL/CETL listing of this fixture.
- When handling the fixture, do not apply pressure to the LEDs. Hold the fixture by the base only.

## **AVERTISSEMENT**

**IMPORTANT: Coupez l'électricité avant TOUTE manipulation.**

- Lisez toutes les instructions avant d'installer.
- Système est destiné à être installé par un électricien qualifié en conformité avec le code national de l'électricité et les règlements locaux. Accédez au panneau central de disjoncteurs ou de fusibles de votre demeure et placez l'interrupteur principal en position d'arrêt (« OFF »).
- Placez l'interrupteur mural en position d'arrêt (« OFF »).

### **MISE EN GARDE**

- Toutes les pièces doivent être utilisées tel qu'il est indiqué dans ces instructions. Ne remplacez pas les pièces, n'en laissez pas de côté et ne les utilisez pas si elles sont usées ou brisées. Le non-respect de ces instructions peut annuler l'homologation ETL/CETL du luminaire.
- Ors de la manipulation de l'appareil, ne pas appliquer de pression à la LED, tenir l'appareil par la seule base.

## **ADVERTENCIA**

**IMPORTANTE: NUNCA intente hacer trabajos sin desconectar el suministro eléctrico.**

- Lea y comprenda todas las instrucciones e ilustraciones por completo antes de proceder con el ensamblaje e instalación de esta lámpara.
- Sistema está diseñado para ser instalado por un electricista calificado, de acuerdo con el código eléctrico nacional y las normas locales.
- Diríjase a la caja de fusibles o a la caja del interruptor de circuito principal en su hogar. Coloque el interruptor de alimentación principal en la posición "OFF" (APAGADO).
- Coloque el interruptor de la pared en la posición "OFF" (APAGADO).

### **PRECAUCIÓN**

- Todas las piezas deben usarse como lo indican estas instrucciones. No reemplace las piezas, noomita piezas durante la instalación ni utilice piezas gastadas o rotas. El incumplimiento de esta indicación podría invalidar la calificación ETL/CETL esta lámpara.
- Al manipular el aparato, no aplique presión a los LED, mantenga el aparato en la base sólo.

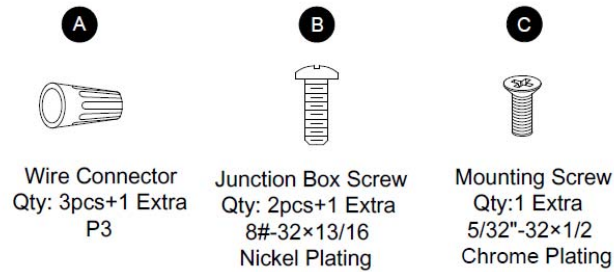

**Fig. 1**

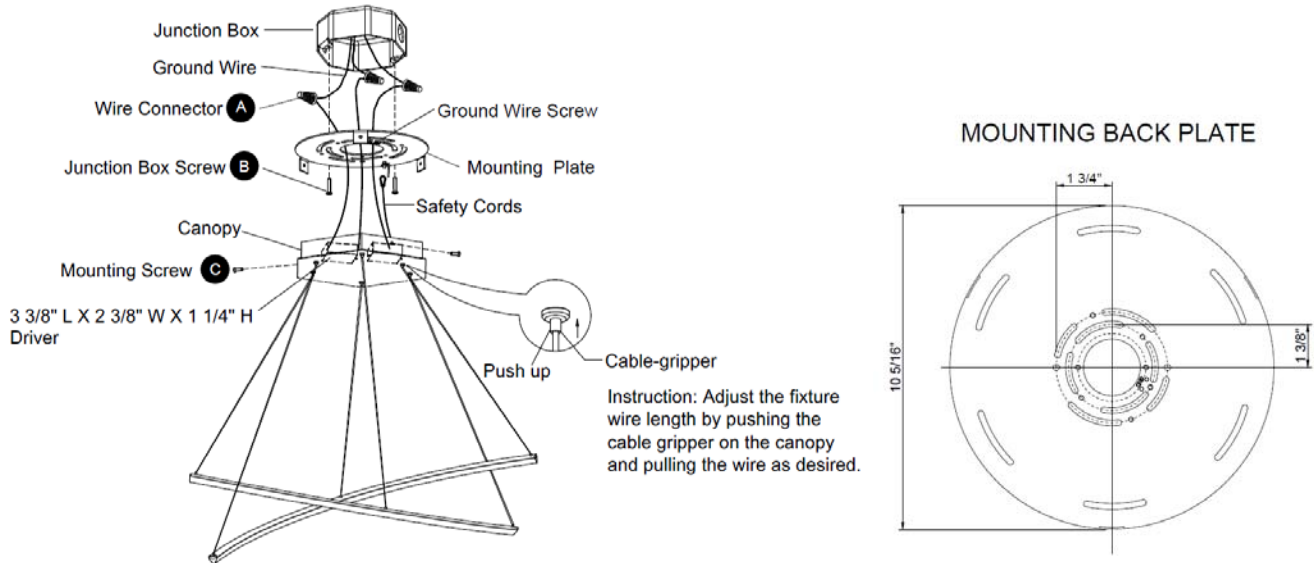

## PREPARATION

1. Shut off the power at the circuit breaker and remove existing fixture, including the crossbar.
2. Carefully unpack your new fixture and lay out all the parts on a clear area. Be careful not to lose any small parts necessary for installation.

## CONNECTING THE WIRES (Fig. 2)

1. Remove the mounting screw (C) from the fixture.
2. Secure the mounting back plate to the junction box using junction box screws (B). The side of the mounting back plate marked "GND" must face out.
3. Properly secure the safety cord to the bracket on mounting back plate to temporarily hang the fixture in place.
4. Adjust the fixture wire length by pushing the cable gripper on the canopy and pulling the wire as desired.
  - a) Retract these wires close to a desirable length to within the canopy before securing the fixture in place. Using the cable gripper to adjust more than 18" of wire length is not desirable.
  - b) **Warning:** Shortening these cables without professional helps or electronic background is not advisable. Any modifications to the fixture may result in voiding the warranty of the product.
5. Connect the Driver's input wires to junction box wires as shown in Fig. 2, making sure that all wire connectors (A) are secured. If your outlet box has a green or bare copper ground wire, connect the fixture's ground wire to it. Otherwise, connect the fixture's ground wire directly to the back plate using the green screw provided. After wires are connected, tuck them carefully inside the junction box.
6. This fixture features electronic low voltage (ELV or TRAIC) or 0-10V dimming capabilities. See notes below for specific dimming wires information.

## MOUNTING THE FIXTURE/ CONNECTING THE WIRE

7. Secure the canopy to the mounting plate using the mounting screw (C).
8. Make final adjustment to desire the cable length.

**Fig. 2 Wiring**

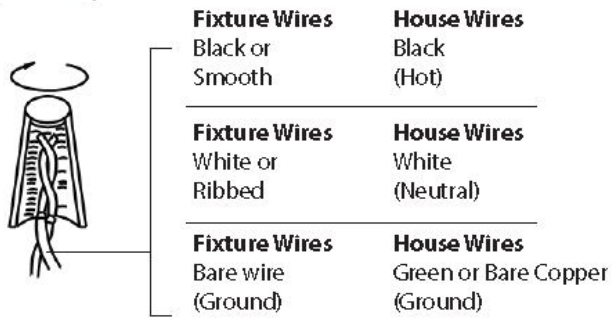

**Fig. 3. Driver Wires**

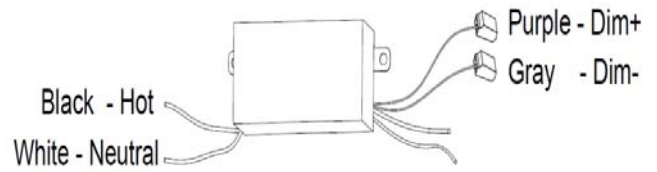

## **WARNING**

**IMPORTANT: NEVER attempt any work without shutting off the electricity.**

- Read all instructions before installing.
- System is intended for installation by a qualified electrician in accordance with the National Electrical Code and local regulations.
- Go to the main fuse box, or circuit breaker. Place the main power switch in the "OFF" position and unscrew the fuse(s) or switch "OFF" the circuit breaker switch(es) that control the power to the fixture or room that you are working on.
- Place the wall switch in the "OFF" position.

### **CAUTION**

- All parts must be used as indicated in these instructions. Do not substitute any parts, leave parts out, or use any parts that are worn out or broken. Failure to follow this instruction could invalidate the ETL/CETL listing of this fixture.
- When handling the fixture, do not apply pressure to the LEDs. Hold the fixture by the base only.

## **AVERTISSEMENT**

**IMPORTANT: Coupez l'électricité avant TOUTE manipulation.**

- Lisez toutes les instructions avant d'installer.
- Système est destiné à être installé par un électricien qualifié en conformité avec le code national de l'électricité et les règlements locaux. Accédez au panneau central de disjoncteurs ou de fusibles de votre demeure et placez l'interrupteur principal en position d'arrêt (« OFF »).
- Placez l'interrupteur mural en position d'arrêt (« OFF »).

### **MISE EN GARDE**

- Toutes les pièces doivent être utilisées tel qu'il est indiqué dans ces instructions. Ne remplacez pas les pièces, n'en laissez pas de côté et ne les utilisez pas si elles sont usées ou brisées. Le non-respect de ces instructions peut annuler l'homologation ETL/CETL du luminaire.
- Ors de la manipulation de l'appareil, ne pas appliquer de pression à la LED, tenir l'appareil par la seule base.

## **ADVERTENCIA**

**IMPORTANTE: NUNCA intente hacer trabajos sin desconectar el suministro eléctrico.**

- Lea y comprenda todas las instrucciones e ilustraciones por completo antes de proceder con el ensamblaje e instalación de esta lámpara.
- Sistema está diseñado para ser instalado por un electricista calificado, de acuerdo con el código eléctrico nacional y las normas locales.
- Diríjase a la caja de fusibles o a la caja del interruptor de circuito principal en su hogar. Coloque el interruptor de alimentación principal en la posición "OFF" (APAGADO).
- Coloque el interruptor de la pared en la posición "OFF" (APAGADO).

### **PRECAUCIÓN**

- Todas las piezas deben usarse como lo indican estas instrucciones. No reemplace las piezas, no omita piezas durante la instalación ni utilice piezas gastadas o rotas. El incumplimiento de esta indicación podría invalidar la calificación ETL/CETL esta lámpara.
- Al manipular el aparato, no aplique presión a los LED, mantenga el aparato en la base sólo.

# HARDWARE

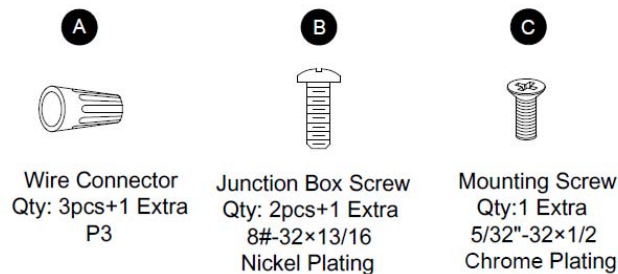
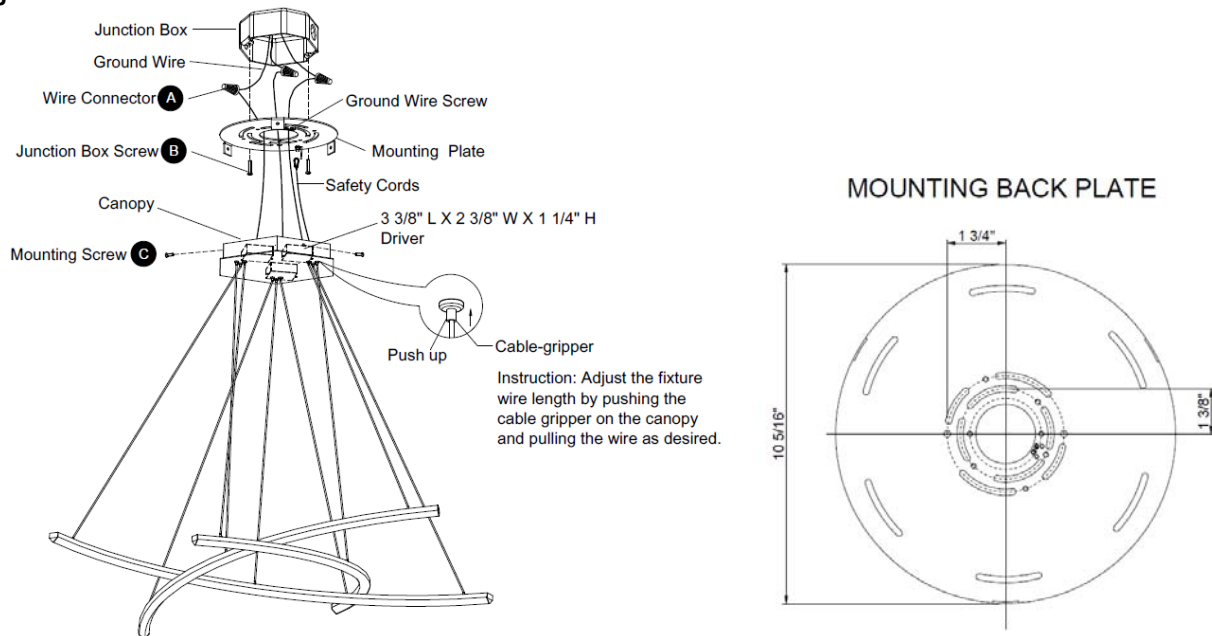

Fig. 1



## PREPARATION

1. Shut off the power at the circuit breaker and remove existing fixture, including the crossbar.
2. Carefully unpack your new fixture and lay out all the parts on a clear area. Be careful not to lose any small parts necessary for installation.

## CONNECTING THE WIRES (Fig. 2)

3. Remove the mounting screw (C) from the fixture.
4. Secure the mounting back plate to the junction box using junction box screws (B). The side of the mounting back plate marked "GND" must face out.
5. Properly secure the safety cord to the bracket on mounting back plate to temporary hang the fixture in place.
6. Adjust the fixture wire length by pushing the cable gripper on the canopy and pulling the wire as desired.
  - a) Retract these wires close to a desirable length to within the canopy before securing the fixture in place. Using the cable gripper to adjust more than 18" of wire length is not desirable.
  - b) **Warning:** Shortening these cables without professional helps or electronic background is not advisable. Any modifications to the fixture may result in voiding the warranty of the product.
7. Connect the Driver's input wires to junction box wires as shown in Fig. 2, making sure that all wire connectors (A) are secured. If your outlet box has a green or bare copper ground wire, connect the fixture's ground wire to it. Otherwise, connect the fixture's ground wire directly to the back plate using the green screw provided. After wires are connected, tuck them carefully inside the junction box.
8. This fixture features electronic low voltage (ELV or TRAIC) or 0-10V dimming capabilities. See notes below for specific dimming wires information.

## MOUNTING THE FIXTURE/ CONNECTING THE WIRE

WAC Lighting  
www.waclighting.com  
Phone (800) 526.2588 • Fax (800) 526.2585

Headquarters/Eastern Distribution Center  
44 Harbor Park Drive • Port Washington, NY 11050  
Phone (516) 515.5000 • Fax (516) 515.5050

Western Distribution Center  
1750 Archibald Ave • Ontario, CA 91761  
Phone (800) 526.2588 • Fax (800) 526.2585



9. Secure the canopy to the mounting plate using the mounting screw (C).
10. Make final adjustment to desire the cable length.

**NOTE: DIMMING WIRING INFORMATION (Fig. 3)**

- To utilize ELV or TRAIC dimming: use wires black (hot), white (neutral) and bare copper ground wire (ground).
- To utilize 0-10V dimming: use wire purple (dim+), gray (dim-), black (hot), white (neutral) and bare copper ground wire (ground).

**Fig. 2 Wiring**

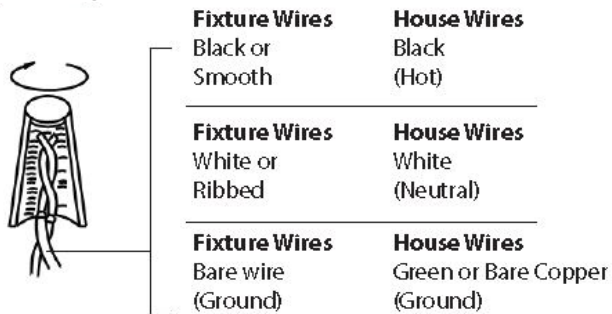

**Fig. 3. Driver Wires**

